

Technical data sheet

**Model TST45
for inward/outward opening doors**

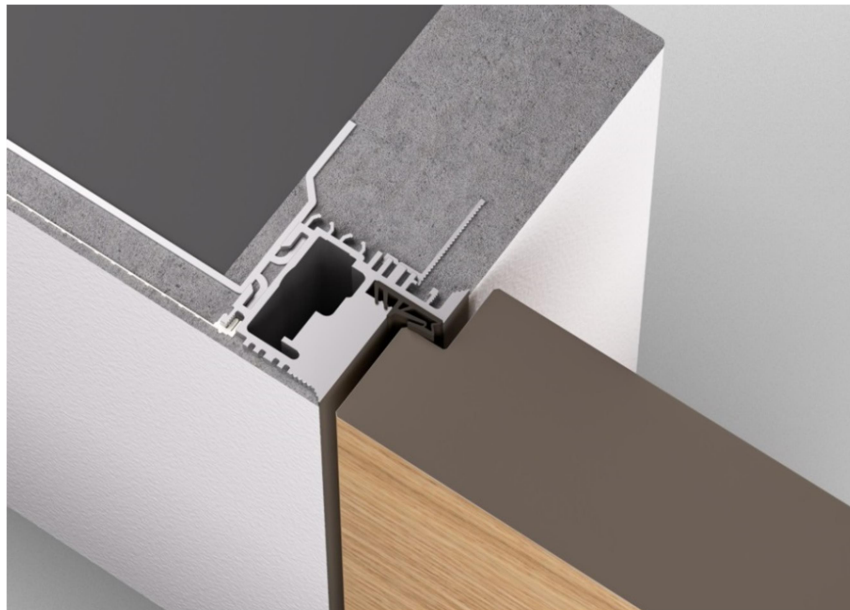

Index

Profile detail.....	2
Recommendations	2
Suitable hinges.....	3
Suitable striking plates.....	3
Suitable door closers.....	4
Suitable seals.....	5
Door leaf	6/7
Inward opening doors	6
Outward opening doors	7

Profile detail

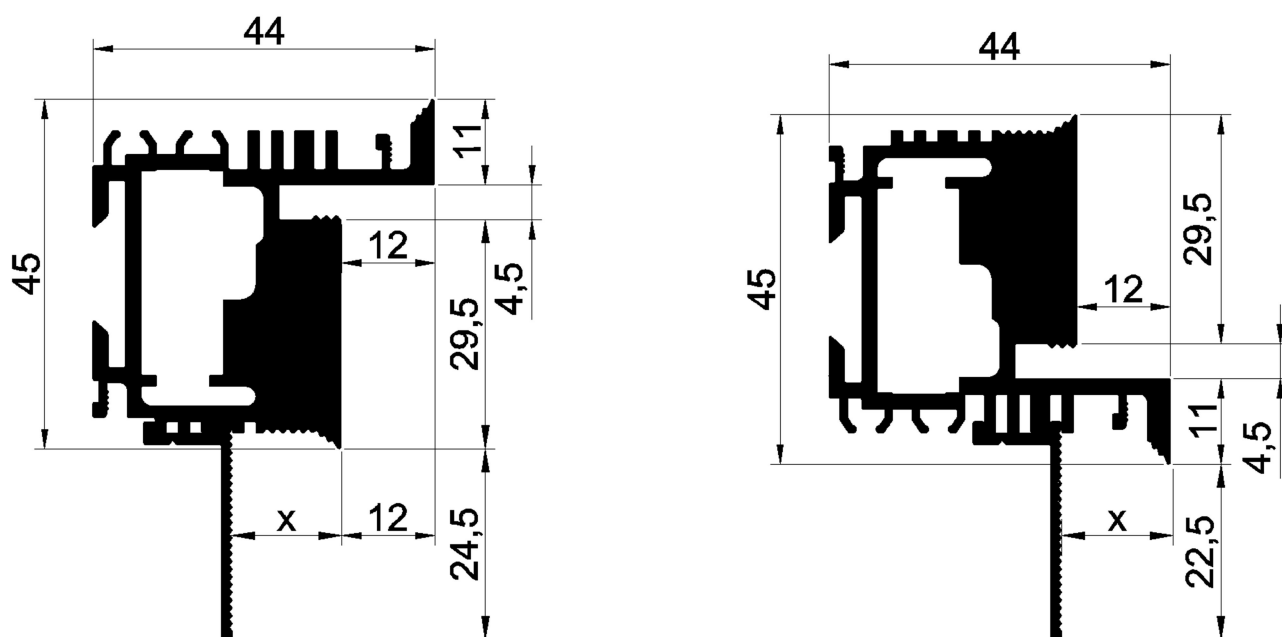

X = 11/14 mm

Model TST45

Suitable for solid and dry construction

The frame profiles are supplied mitre-cut to suit door size, and machined to suit concealed hinges, lock strikes and other hardware. In combination with the snapIn corner connectors and the mounting brackets, this enables quick assembly and professional installation. The snap-in mesh ensures no plaster cracks between wall and frame. Suits standard or floor-to-ceiling doors.

Here you can find the assembling video:



masonry construction



drywall

Recommendations

On the basis of detailed tests and long-term experiences our technical office has prepared a recommendation-list regarding the selection of hinges, closing panels and seals. These lists are practical guidelines and non-exhaustive.

RECOMMENDATION		
Suitable hinges		
Producer	Designation	Weight
AGB www.agb.it	Eclipse 3.0	40/60 kg
	Eclipse 3.2	40/60 kg
Anselmi www.anselmisrl.it	AN 140 3D	40 kg
	AN 150 3D	40 kg
	AN 160 3D	60 kg
	AN 180 3D	80 kg
Basys www.basys.biz	Pivota DX38 „N“ 3-D (Design)	60 kg
	Pivota DX42 3-D (Design)	60 kg
	Pivota DX43 3-D (Design)	60 kg
Ceam www.ceamitalia.it	1129	40 kg
	1329	35 kg
	1430	60 kg
Krona Koblenz www.kronakoblenz.com	Kubica K2400	40/60 kg
	Kubica K6400	30/45 kg
	Kombi K1019	40/52 kg
	Atomika Slim K8060	60 kg
Otlav www.otlav.it	Invisacta IN 230	40/60 kg
	Invisacta IN 235	40 kg
Simonswerk www.simonswerk.it	Tectus TE 240 3-D	60 kg

RECOMMENDATION	
Suitable striking plates	
Producer	Designation
AGB www.agb.it	Minimal PLUS XT B02402.28.XX
	Easy-Matic XT B01402.11.XX
	Easy-Fix B01402.11.XX

	Alutop XT B02402.09.XX
	Minimal XT B02402.05.XX
	Electric B02800.90.XX
Basys www.basys.biz	Basys SBL 2-L adjustable V3 li/re magnetic
Bonaiti Serrature SpA www.bonaiti.it	G992
	G994
	G995
	GI98
	GIR8
	GIS8
	GR95
	GR96
	GR97
	GS91
Dormakaba www.dormakaba.com	SB/MAG/210.20.2,0
	SB12/MAG/VAR/DS
	SB/MAG/120.20.2,0
KFV www.kfv.de	FSS 116-200-20HR/41
	FSS 116-245-20HR/41
	FSS 116-245-18HR/41
	FSS 116-120-20HR/41
SSF www.ssf.de	MG 50
Simonswerk www.simonswerk.it	KCM 50
	CM 50/H

RECOMMENDATION Suitable door closers	
Producer	Designation
Athmer www.athmer.com	PORTI 5371

RECOMMENDATION
Suitable seals/gaskets

Producer	Designation
Deventer Profile GmbH www.deventer-profile.com	DS 6922a
Helmut Goll GmbH www.helmutgoll.com	A1020
Primo Profile GmbH www.primo.com	ACF 5602 H
SchlegelGiesse – Giesse S.p.A www.schlegelgiesse.com	QL 3096
	QL 3104

Door leaf

Inward opening doors

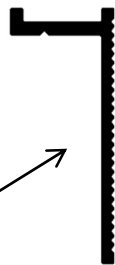
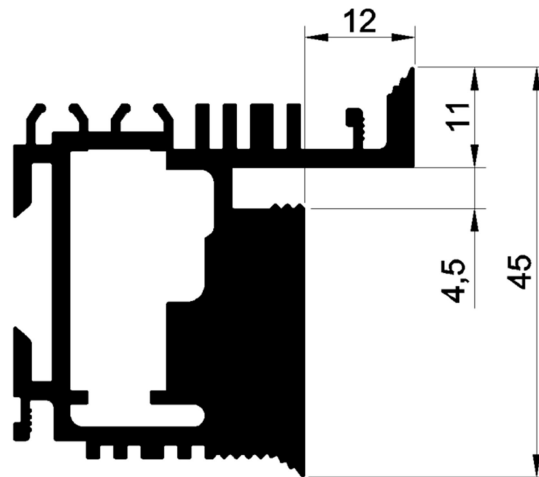

Detachable profile for drywall

Rebate dimension for 5mm door seal

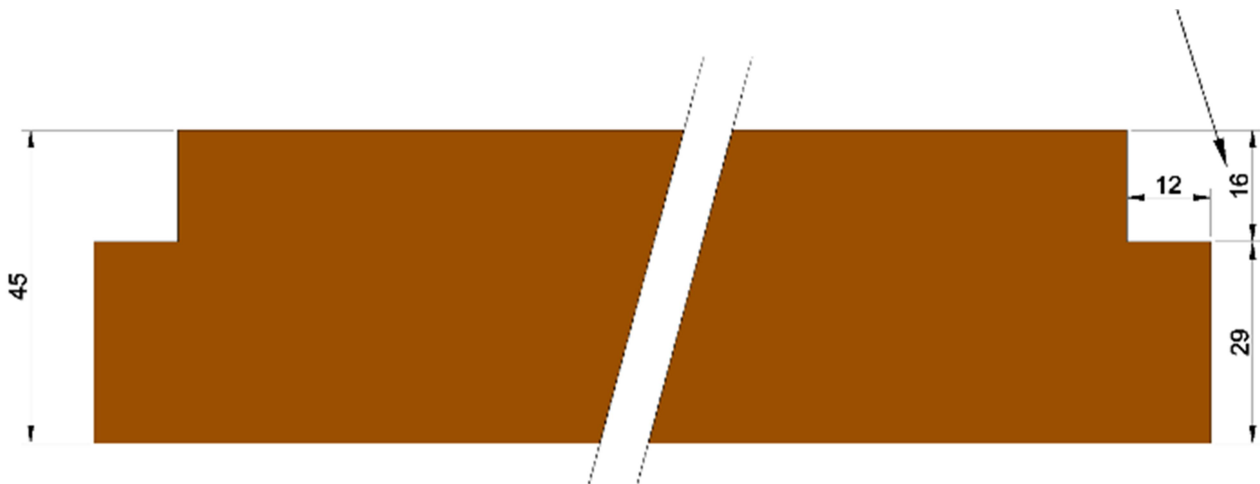

Outward opening doors

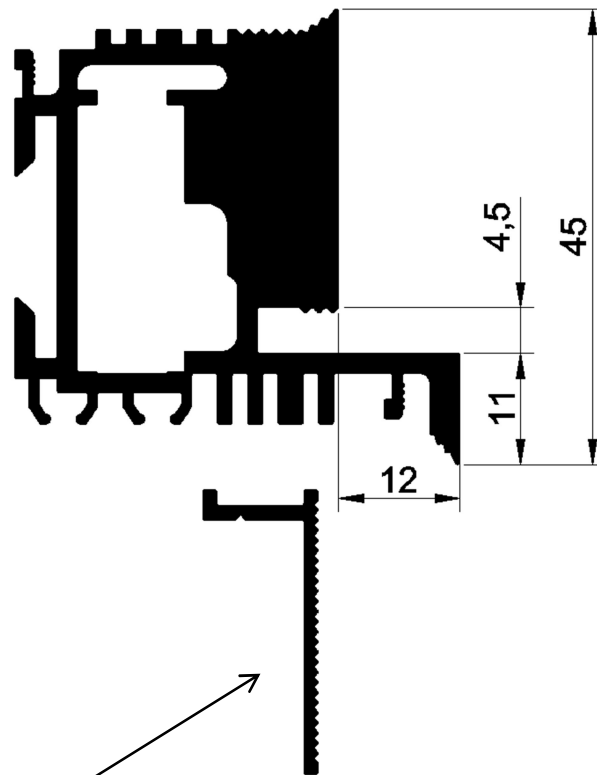

Detachable profile for drywall

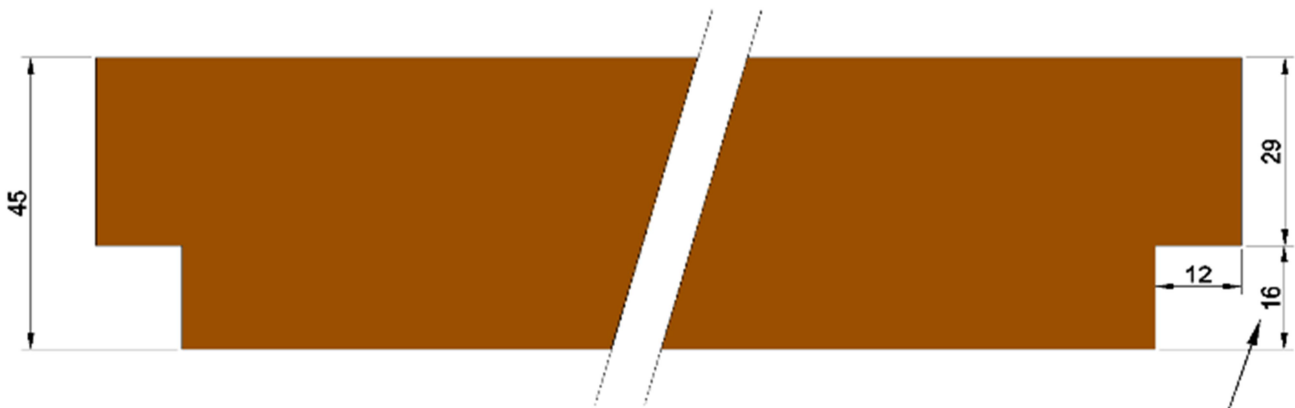

Rebate dimension for 5mm door seal

We guarantee for a high quality of our products. Our processing guidelines are based on tests and practical experiences; they are only indication without assurance of properties, we have no influence on condition of construction sites and the realizations of the works.

Country specific regulations, which consist on regional standards, building regulations, processing and industrial guidelines, can guide to specific processing recommendations.